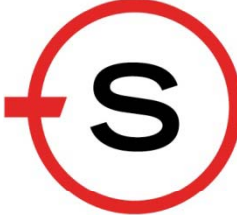

LEA

CERAMICHE

 **SLIMTECH**

CORSO SLIMTECH

1. L'AZIENDA

- Presentazione aziendale

2. IL PRODOTTO

- Video
- Serie - Gamma cromatica
- Formati
- Spessori

3. IL PROCESSO PRODUTTIVO

- Tecnologia innovativa:
 - Tecnica produttiva
 - Stampa digitale
 - Lea Green
- Protezione antibatterica Microban
- Video

4. DESTINAZIONI D'USO

- Posa a pavimento
- Posa a parete

5. DESTINAZIONI SPECIALI

- Pareti ventilate
- Cappotti termici
- Soluzioni tecniche:
 - Piscine
 - Settore dell'arredamento
 - Saune

6. LEA LAB

- Rivoluzionaria tecnologia di stampa

PANARIAGROUP

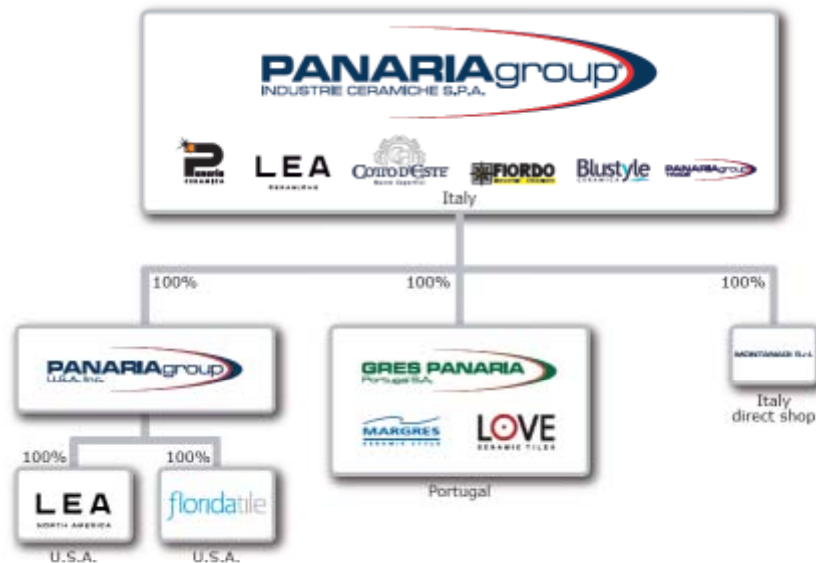

- CORE BUSINESS:
Produzione di piastrelle in ceramica (80 % gres porcellanato)
- 6 SITI DI PRODUZIONE
- 8 BRAND
- CAPACITA':
 - *25.000.000 mq / anno*
- FATTURATO:
 - *273.000.000 €/anno (2013)*
- 1.800 IMPIEGATI
- 10.000 CLIENTI NEL MONDO

L'AZIENDA

ECCELLENZA, INNOVAZIONE, ESTETICA, COMPETENZA

La capacità innovativa dell'azienda si basa su una continua sperimentazione che grazie allo sviluppo di sistemi produttivi e tecnologie all'avanguardia è in grado di proporre una vasta gamma di prodotti di alta qualità, particolarmente riconoscibili per la spiccata impronta stilistica e l'elevato contenuto di ricerca e design.



IL PRODOTTO

GRES SMALTATO

Serie: Dreaming

GRES TUTTA MASSA

Serie: Tecnoquartz

MONOPOROSA

Serie: Kensington

GRES LAMINATO SLIMTECH

Serie: Slimtech Basaltina



SLIMTECH

- Una lastra sottile di soli 3 o 5 mm
A slab only 3 or 5 mm thick
- Dimensioni record, fino a 100x300 cm
Record dimensions, up to 100x300 cm
- Planare
Planar
- Per rinnovare il rivestimento e pavimento
To easily renovate floors and walls



WOOD-STOCK Slimtech vintage wood



TIMELESS MARBLE Slimtech white marble lev

- Facile da tagliare
Easy to cut
- Resistente alle macchie e agenti chimici
Resistant to stains and chemical agents
- Resistente ad alto traffico
Ideal for high-traffic areas
- Nuova tecnologia, attenta all'ecologia
New technology, eco-friendly
- Più mq per ogni carico
More sqm per shipment



TIMELESS MARBLE Slimtech beige marble lev



WOOD-STOCK Slimtech coffee wood

GAMMA CROMATICA

Basaltina Stone Project



Lappata Stuccata Naturale Sabbiata

Arenaria



Brown Caramel Sabbia Avorio

Gouache .10 design Diego Grandi



Black Stone Light Rock Soft Sand White Cloud Crystal Water Cool Rain Deep Sea

Lines / Waves design Patrick Norguet

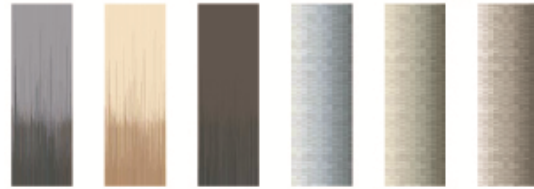

Line Blue Line Yellow Line Grey Wave Blue Wave Green Wave Grey

RE-evolution



SRW010 SRW020 SRW030 SRC010 SRC020 SRC030

Shade



Milk Black Coffee

Absolute



Total White low Total White sat. Total Black low Total Black sat.

Timeless Marble



Statuario White low Statuario White sat. Safari Amande low Safari Amande sat. Travertino classico low Travertino classico sat. Pietra Gray low Pietra Gray sat.

Wood-stock



Snow Wood Cream Wood Nut Wood Honey Wood Vintage Wood Coffee Wood

FORMATI



39"x118"
100x300cm



39"x39"
100x100cm



19^{1/2}"x39"
50x100cm



19^{1/2}"x19^{1/2}"
50x50cm



2"x39"
4,9x100cm



13"x118"
33x300cm



8"x79"
20x200cm



8"x59"
20x150cm



8"x39"
20x100cm



19^{1/2}"x59"
50x150cm



13"x39"
33x100cm

SPESSORI

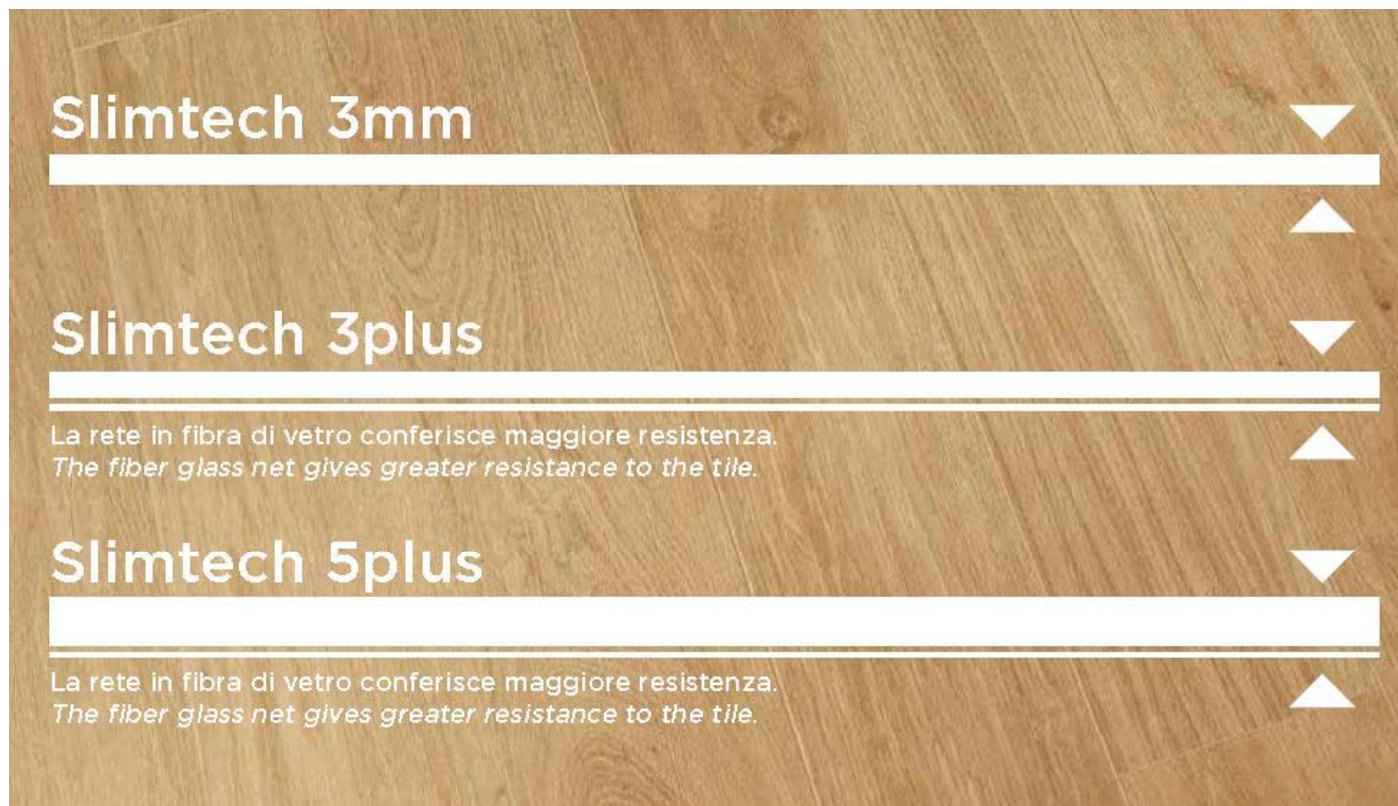

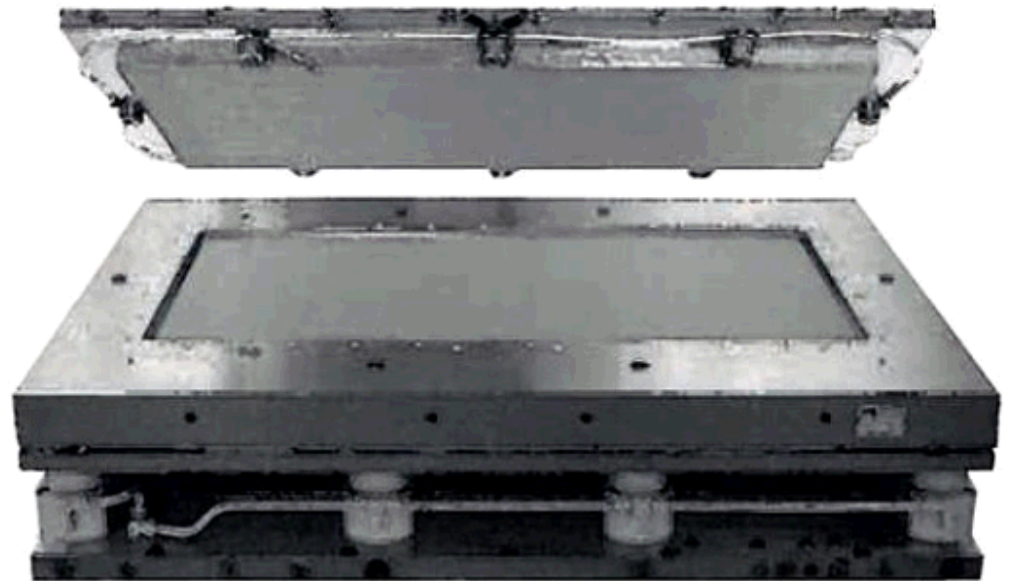

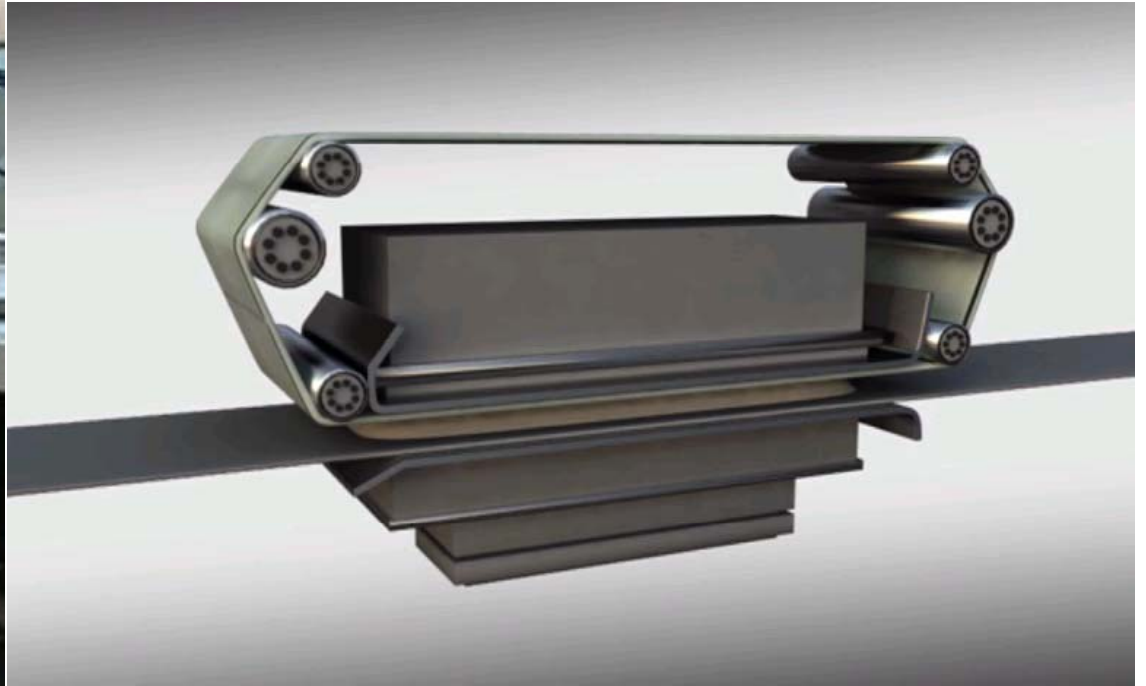

Non trattato



2 ore

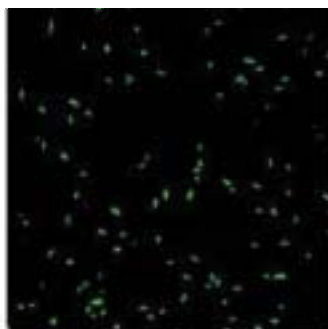

16 ore

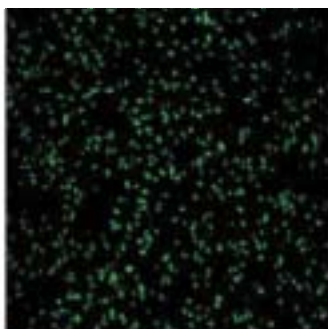

20 ore

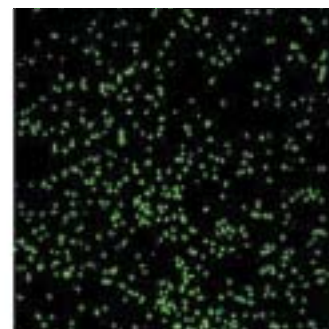

24 ore

Trattato con Microban[®]

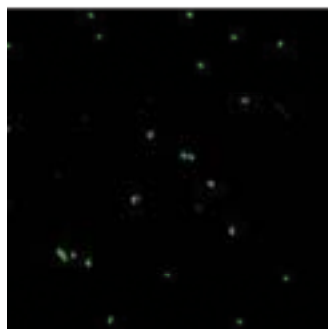

2 ore

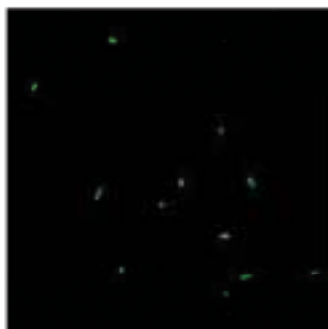

16 ore

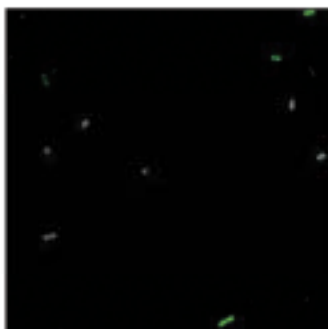

20 ore



24 ore

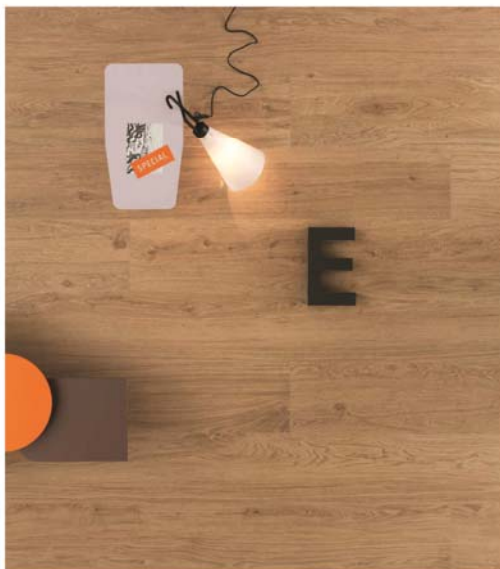

WOOD-STOCK Slimtech honey wood



ABSOLUTE Slimtech total black lev



ABSOLUTE Slimtech total white lev



WOOD-STOCK Slimtech nut wood

 **Microban**[®]
protezione antibatterica

- Attiva 24 ore su 24
Active 24/7
- Efficace contro i batteri
Effective against bacteria
- Molteplici applicazioni ed utilizzi
Multiple applications and uses
- Trattamento permanente
Permanent protection
- Integrata nella piastrella
Integrated in the tile
- Efficace su ogni superficie
Efficient on any surface
- Conforme alle normative di sicurezza
Safety and regulatory compliance
- Applicabile a piastrelle di ogni colore
Applicable to tiles of any colour
- Incrementa il livello di igiene della superficie
Improve the hygienic level of the surface

DESTINAZIONI SPECIALI

- Pareti ventilate
- Cappotti termici
- Pavimenti sopraelevati
- Piscine
- Settore dell'arredamento
- Saune
- Hammam
- Pavimenti riscaldati



Pareti ventilate





LEA CERAMICHE



Pareti ventilate - Sistema "Luna Slot"



Pareti ventilate - Sistema "Luna Vista"

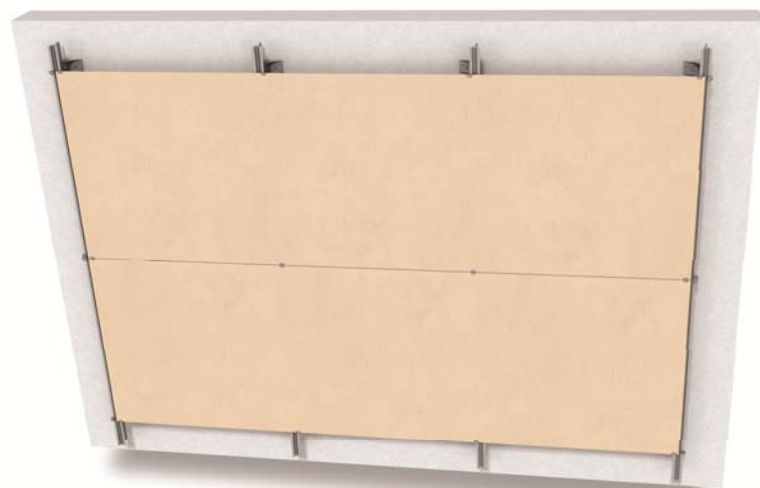

Cappotti termici



Cappotti termici - CeraVent

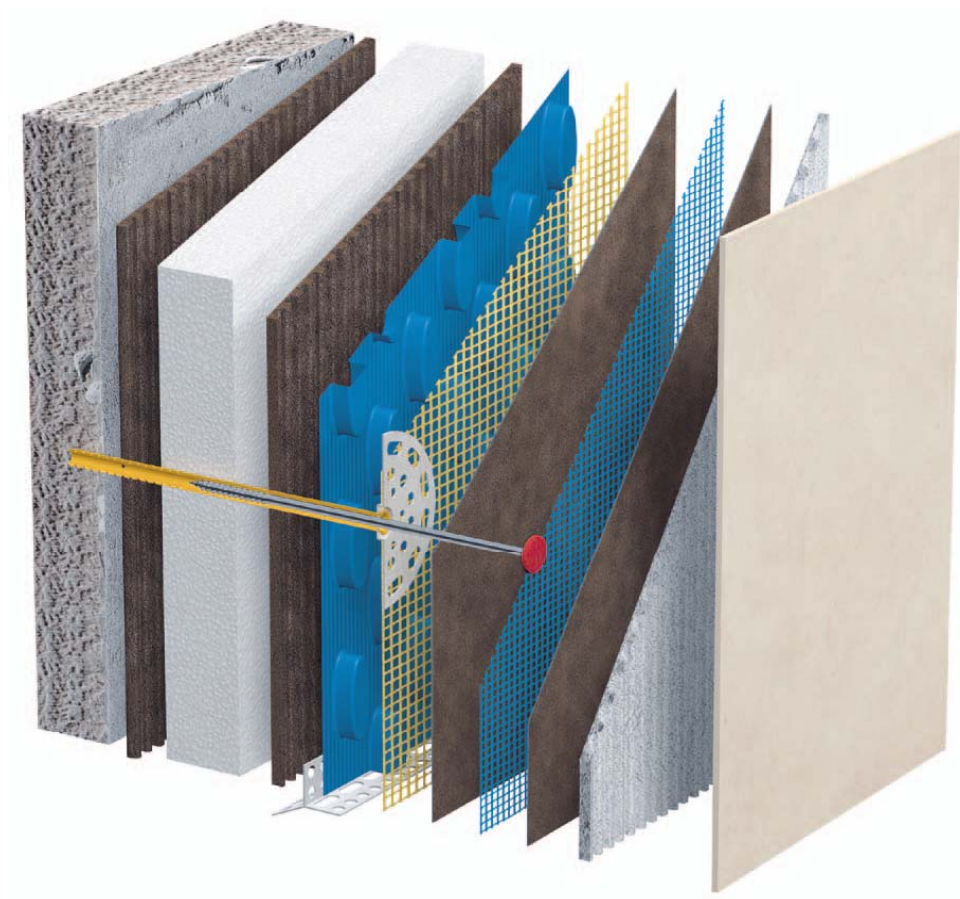

Hammam



Pavimenti sopraelevati



Settore dell'arredamento







LEA LAB

Lea Lab è un nuovo concept che abbina una rivoluzionaria tecnologia di stampa a Slimtech.

Da oggi è possibile stampare qualsiasi immagine ad alta definizione con risultati cromatici di altissima qualità e realizzare progetti personalizzati in quantitativi minimi.

LEALAB



LEA CERAMICHE



LEALAB



LEALAB



LEA CERAMICHE





MANUALE TECNICO



Grazie